



MODEL 470



Table of Contents

Introduction	1	Changing A Speed Dial Entry... 13	To directly edit a Speed Dial softkey	13
Emergency Service Feature.....	1	To Delete a Speed Dial softkey 14	Only Erase the Speed Dial softkey	14
Unpacking the Phone.....	1	Completely Erase the entry from the telephone.....	14	
Key Description	2	Locking the Speed Dial softkey 14	To unlock Speed Dial and Directory	14
Installation	4	Dialing Using a Speed Dial softkey.....	14	
Prompts and Indicators	6	To place a Speed Dial call with the handset	14	
How do I use softkeys?	6	Assigning a Caller's List Entry to a Speed Dial softkey	14	
Display Prompts	6	Assigning a Redial List Entry to a Speed Dial softkey... ..	15	
Making and Answering Calls	7	Assigning a Directory Entry to a different blank Button... ..	15	
Predialing a number	7	Using the Callers List	17	
Handsfree Calling	7	Viewing the Callers List.....	17	
Timing a call	7	Calling an entry in the Callers List	17	
Using Flash	7	Copying from the Callers List to the Directory	17	
Extension in Use	7	Changing a number in the Callers List before dialing	17	
Using the Redial List	7	Deleting an entry in the Callers List.....	17	
Status lights	8	Deleting all entries in the Callers List.....	17	
Using Hold key	8	Headset/ Dataport Operation ...	18	
Adjusting the Volume	8	Using a Headset with your Telephone	18	
Customizing your phone	9	Making and Receiving Calls using a Headset	18	
Setting your Options	9	Using the Dataport	18	
Using the Directory	11	Icons	19	
Adding a name and number to the Directory.....	11	Troubleshooting	20	
Entering Letters and Characters	11	Limited Warranty	22	
Finding entries in the Directory.....	11			
Changing entries in the Directory.....	12			
Copying to the Directory.....	12			
Dialing from the Directory.....	12			
Deleting an entry in the Directory.....	12			
Deleting all entries in the Directory.....	12			
Locking the Directory	12			
Softkey Memory	13			
Saving a name and number to a Softkey Button.....	13			
Finding entries in the Speed Dial softkey.....	13			

Introduction

Congratulations on your purchase of the Model 470 telephone! The Model 470 boasts several timesaving and advanced features, including:

- a large 8-line backlit display
- a 50 Name/Number Directory with 50 entry Callers List
- a speakerphone for handsfree calls
- up to 30 one-touch, on screen speed dial positions
- a jack for headset usage

Use this guide to learn more about the Model 470's features.

Emergency Service Feature

The Model 470 will provide basic telephone service during a power failure. However, only the dial pad, ringer and handset will function. If you are on a handset call during a power interruption, the Model 470 will keep the call, although the display will not work while the power is off. Handsfree calls will not be re-established during a power interruption.

Unpacking the Phone

When you unpack your telephone, you should ensure that you have all of the following items. If any part is missing, contact the supplier of your telephone.

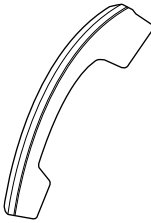

handset

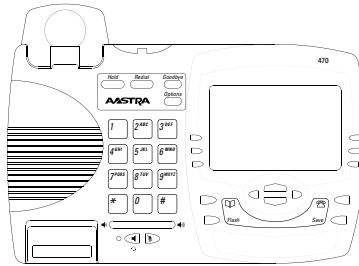

telephone

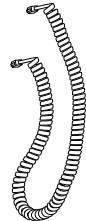

handset cord



2 line cord

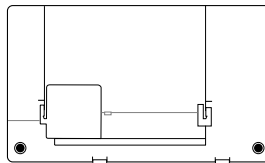

stand



number card and lens

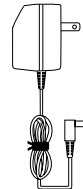







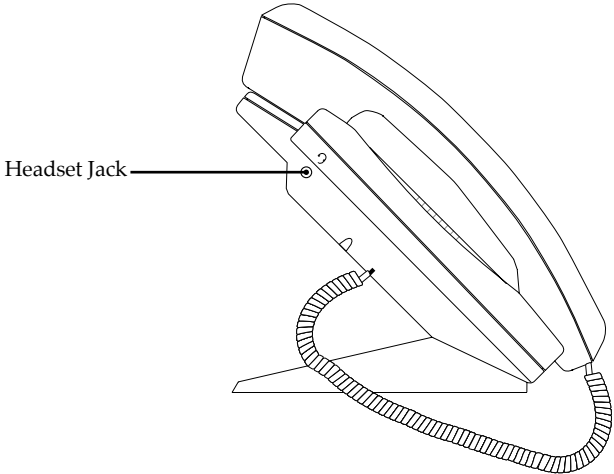
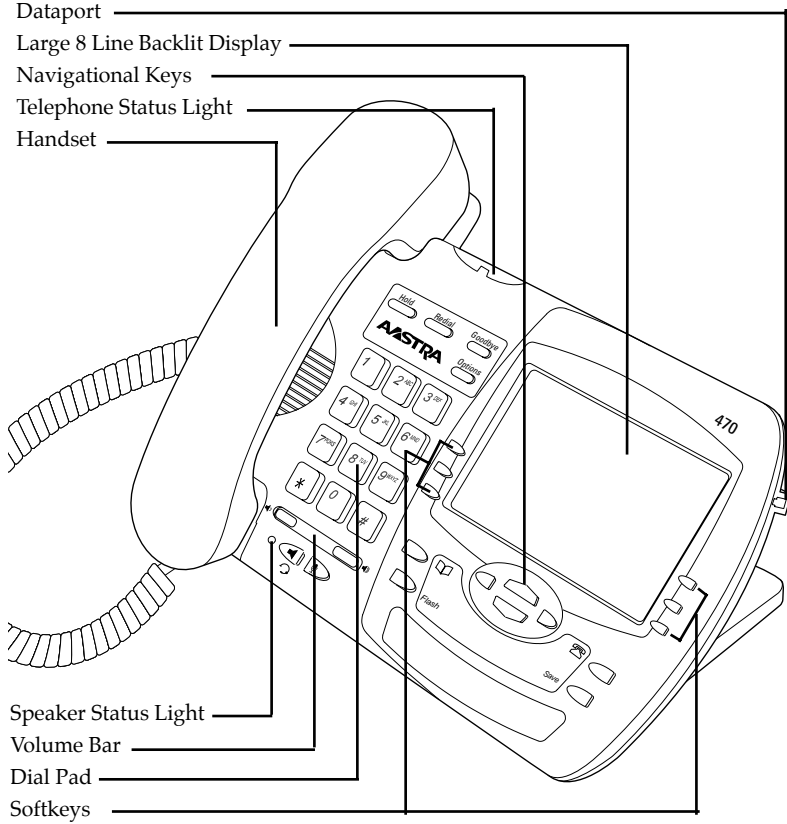















power adaptor

The power adaptor is 16 VAC, 250mA – please see the regulatory sheet for safety instructions regarding the power adaptor and operation of the telephone.

Key Description



Keys	Key Description
	Places an active call on hold or releases this call from being held. This key also enters pauses during predial or editing mode. See the section "Using Hold key" for more information.
	Displays the last 5 numbers dialed. See the section "Using the Redial List" for more information.
	Pressing  ends an active call.  exits an open list, such as the Directory or Callers List, but if a call is active when the list is open, it will also end the call. It will not hang up a call that is on hold.
	 lets you access nine options to customize your telephone. See the section "Customizing your phone" for more information.
	Adjusts the volume for the handset, headset, ringer and handsfree speaker. See the section "Adjusting the Volume" for more information.
	Pressing  activates Handsfree so you can make and receive calls without lifting the handset. When the audio mode option is activated, this key is used to switch between a headset and the Handsfree speakerphone. See the sections "Handsfree calling" and "Customizing your phone" for more information.
	Mute, when activated, prevents the caller from hearing you through the handsfree, handset or headset. The display will show MicroPHONE Muted . When a Handsfree or Headset call is muted, the speaker light blinks. To take a call off mute, press  again.
	Directory, which can store up to 50 names and numbers in alphabetical order. See the section "Using the Directory" for more information.
	Pressing  allows access to telephone company subscribed services such as call waiting and three-way calling.
	Pressing  and  lets you move between screens when you are using services. These buttons also let you scroll through menu selections, such as the Options List. When you are editing entries on the display,  deletes a character or number, and  adds a space when entering or editing names.
	Callers List, which stores the last 50 callers. See the section "Using the Callers List" for more information.
	Pressing  . Will save names and numbers to the Directory or a Softkey Memory.

Installation

Your Model 470 telephone can be installed on a desk or mounted on the wall. To use the phone's Call Waiting and Caller Identification capabilities, contact your local Service Provider for subscription details. Your Service Provider may call these services by different names.



1. Connect the handset cord

Turn the telephone over and locate the handset jack marked . Insert one end of handset cord into the jack until it clicks into place. Then route the handset cord through the groove as shown in the illustration below.

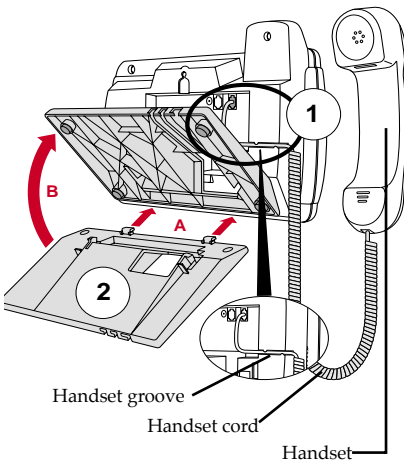
Attach the handset to the other end of the handset cord.





2. Attach the stand

If you plan to mount the phone on the wall, you do not need to attach the stand; skip this step. If you plan to use the phone on a desk, attach the stand by inserting the tabs on the stand (marked with ) into the slots on the bottom of the telephone (A). For a higher viewing angle, use the slots marked . For a lower

viewing angle, use the slots marked . Then slide the stand towards the phone until it snaps into place (B).

3. Connect the cords

If you attached the stand to install the phone on a desk, route both the phone cord and power adapter cord through the opening in the stand. Insert the phone cord into the slot on the back of the telephone marked  until it clicks into place. Insert the power cord into the power jack marked .

4. Press the cords into grooves

Press the cords into two of the grooves provided on the bottom of the stand. This will allow the stand to sit flat on a desk surface.

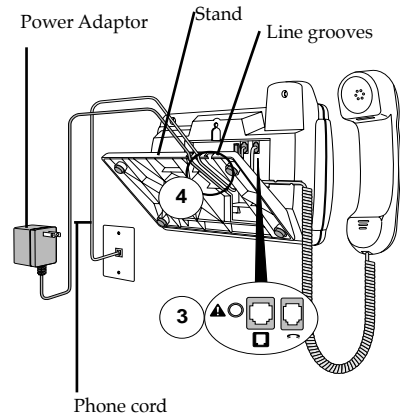

5. Install the phone

If you have installed the stand and are using the phone on a desk: Simply turn the telephone over so it rests on the stand. Connect the phone cord to a phone jack and plug the power adapter into a power outlet.

Note: You should connect the power adaptor to a surge protector or power bar.

6. Install on a wall

To install the Model 470 on a wall: Connect the cord to the wall jack (A). Coil the phone cord into the space provided on the back of the phone (B). Then align the telephone so the hooks on the wall plate (C) align with the wall-mount slots on the back of the phone, as shown here. Push the phone onto the pegs, then slide it down until it is secure (D). Plug the power adaptor into a power outlet (E).

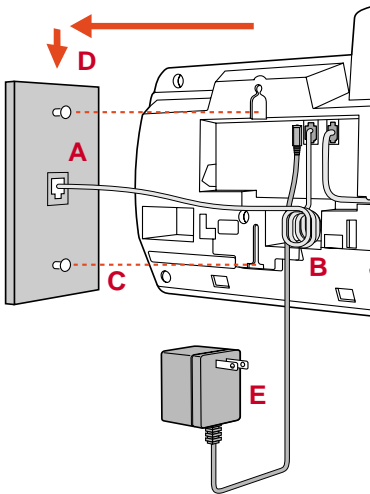

Note: You should connect the power adaptor to a surge protector or power bar.

7. Insert number card

Write your telephone number on the number card, and place it into the card slot on the telephone, located under the mouthpiece in the handset cradle. Gently bend the clear plastic lens into the slot, over the number card.

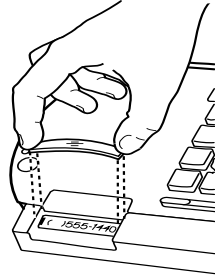

8. Customize the telephone

Follow the instructions in the section “Customizing your phone” to customize your Model 470 telephone.

Prompts and Indicators

How do I use softkeys?

This telephone uses softkeys to both give you commands to choose from and to use as Speed Dial keys. Each

choice corresponds to the button next to it. In this illustration, the user is selecting **NextSpace** to insert a space. Commands will change depending upon the action you are performing.

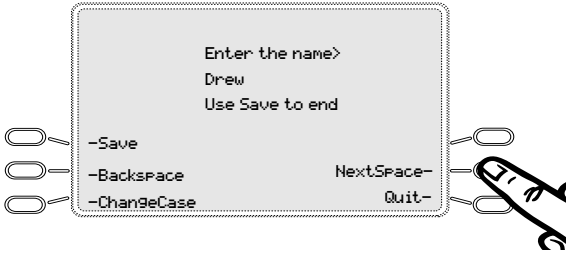

Display Prompts

Instructions and information are displayed on the large screen. If you are unsure what a certain prompt



means, find it here, or see the **Troubleshooting** or index section for additional information.

Display Prompt	Explanation
Call is on hold	A call is on hold. Press the Hold key or the Handsfree key to speak with the caller.
Check phone cord	A line cord (☐) may not be connected properly.
Directory is full	The Directory has reached its maximum number of entries. If you want to add entries, you must first delete some entries.
Directory locked	The Directory has been locked, and you cannot edit, add, or delete entries. See the section “Using the Directory ” for more information.
Message Waiting	Check for new messages in your Voice Mail service*.
Private Name or Private Number	The caller has requested that the name (or number) not be shown.
Ringer is OFF	No audible ringing. To turn the ringer on again, press the right side of ☎ .
Unknown name or Unknown number	The telephone company is unable to provide the name (or number) of the caller.
XX New callers	XX new calls have been added to the Callers List since you last checked it.
XX Call(s) bumped	XX callers have been deleted from the Callers List to make room for new callers.

* You must subscribe to a Message Waiting service for this feature to work. Consult your local telephone company for information.







Making and Answering Calls

Predialing a number

Predialing lets you view a number before you dial. Enter the number using the dial pad before lifting the handset. Use the **Backspace** softkey or  to correct any errors. To dial the number, lift the handset, or press the **Dial** softkey, or press .

Note: This feature is not available if you choose to use the Live DialPad option. See the section "**Customizing your phone**" for more information.

Handsfree Calling



The Handsfree feature allows you to speak to someone without using the handset. To dial using Handsfree, enter a number and then press  or the **Dial** softkey. To answer using Handsfree, press  when a call is ringing. To switch between Handsfree and the handset when the handset is off hook, press . When the handset is on hook, press  to disconnect a Handsfree call. When Handsfree is on, the speaker light turns on. When the speaker light is on, press  at any time to mute Handsfree. The speaker light will flash and you will hear the caller, but they will not hear you. To switch between Handsfree and mute press .

Note: Handsfree operation as described above will be affected if the audio mode option has been activated. See the section "**Customizing your phone**" for more information.

Timing a call

When you make or answer a call, the Timer shows the elapsed time of the call.

Using Flash

The  key allows you to access telephone company subscribed services, such as call waiting and three-way calling. These services vary from area to area, so contact your telephone company for instructions on using available services with your Model 470 telephone. If these instructions say to press the "hook-switch" or "receiver button," press the  key.

Extension in Use





The **Extension in use** prompt appears on the telephone display and the telephone status light turns on when someone uses another telephone on the same line.

This message also appears when the telephone is not properly connected to a phone line.

Using the Redial List

The Redial List records the last 5 numbers you dialed.

Redialing a number

1. Press  to view the Redial List.
2. Use the   keys to move the cursor to the number you want to dial.
3. Lift the handset to dial the number, or press the **Dial** softkey or  to dial the number using Handsfree.

Deleting the Redial List

1. Press  to view the Redial List.
2. Press the **DeleteList** softkey.
3. Press the **Delete** softkey to confirm.

Status lights

Speaker Light



- Speaker light is on: a call is on Handsfree (speaker).
- Speaker light flashes slowly: indicates that the headset/handsfree option is being used. See the section "**Customizing your phone**" for more information.
- Speaker light flashes and the display shows **Microphone muted**: a call is muted. Press  to take the call off mute.

Telephone Light

- Light flashes and the display shows **Call is on hold**: a call is on hold. Press  or lift the handset to take the call off hold.
- Light flashes and the display shows **Message Waiting**: a message is waiting for you at your message or voice mail service[†].
- Light flashes quickly and the ringer sounds: you have an incoming call.
- Light is on and the display shows **Extension in use**: an extension telephone is using the line. The message also appears when the telephone is not properly connected to a phone line.

Using Hold key

Pressing  puts a call on hold.

- You can hang up the handset without losing the call.
- The display will show the message **Call is on hold**.
- The telephone light will flash.
- To retrieve the call, lift the handset or press  again. You can also press  to retrieve a Headset or Handsfree call.

Note: A call is taken off hold automatically after 15 minutes. If the handset is on the phone, the call will be disconnected. If the handset is off, the caller will be able to hear you again.

Adjusting the Volume

Pressing the volume button adjusts the receiver, headset, speaker, and ringer volume.

- To adjust the ringer volume, leave the handset in the cradle and press the volume bar  while there is no active call. There are 8 settings for the ringer – the display will temporarily indicate the current ringer volume setting.
- To adjust the handset volume, lift the handset and press the volume button while you are on a call. The handset will return to the default volume after you hang up.
- To adjust the headset volume, press the volume button while on a call. The headset will return to the default volume after you end the call.

Note: The default handset and headset volume is always set at medium.

- To adjust the speaker volume, press the volume button while the speaker is activated (activate the speaker by pressing ). The speaker will remain at this volume until it is adjusted again.





[†] You must subscribe to a Message Waiting service for this feature to work. Consult your local telephone company for information.

Customizing your phone

There are nine configuration options, accessed by pressing

 .

Setting your Options

1. Press  to enter the Options List.
2. Use  and  to scroll through the list of nine options.
3. Press the **Show** softkey to configure an option.
4. Use the softkeys to change a selected option.
5. Press the **Done** softkey at any time to exit the option, or press  to exit the Options list.

The following nine options may be changed on the Model 470:

1. Language – Select a language for the display prompts (English, French, or Spanish).

2. Time / Date – Use this option to change the time and date setting on the display. Press the appropriate softkey to increase that item by 1. For example, press the **Hour** softkey to increase the hour from 1 to 2.

Note: The time and date are automatically set when the phone receives its first Caller ID[†] call.

3. Set ring tone – Press the **Change** softkey to select one of four ring tones.

4. Clear Msg. Wtg. – Sometimes the **Message Waiting** prompt will appear and the light will flash when there are no messages waiting on your Voice Mail[†] service. When in this option, select the **Clear** softkey to clear the prompt and flashing

light. The light will flash again when there are new messages waiting.

5. Area Code – In some locations, you cannot dial a local number using the area code. By default, incoming calls are recorded with area codes in the Callers List. This option allows you to enter up to three local area codes to be removed from incoming calls. Press the **Change** softkey to enter an area code.

6. Contrast Level – Use the **Change** softkey to cycle through 8 contrast settings, which brighten or darken the display.

7. Security Numbers – This option allows you to keep selected numbers from appearing on the screen when dialed. Use this option to protect passwords, access codes etc. When a security number is used, your telephone displays the asterisk * symbol for all digits entered after the security number and the digits do not appear in the Redial list display. Up to three security numbers can be created using this option. Press the **Change** softkey and then enter your code.

8. Live Dialpad – Use this option to turn on or off the dial pad mode. With live dialpad on, the telephone automatically dials out and turns on Handsfree as soon a dial pad key or softkey is pressed. With live dialpad off, you must dial the number first and then lift the handset or press the  button before the number is dialed. Press the **Change** soft key to turn on or off the dial pad mode.

9. Set Audio – The Model 470 telephone allows you to use a handset, headset or handsfree to

handle incoming and outgoing calls. This option provides different combinations of these three methods to provide maximum flexibility in handling calls. No matter which option is chosen, the handset can always be used to answer and place calls. There are four options to choose from:

- **Handsfree** – this is the default setting. Calls can be made or received using the handset or handsfree speakerphone and can be switched between the two modes.
- **Headset** – choose this setting if you want to make or receive all calls using a headset. The speakerphone is disabled in this mode and the speakerphone button is used to answer or place calls while using the headset.
- **Spkr/Hset** – calls will be sent to the handsfree speakerphone. By pressing the ◀/▶ button on the phone you can switch between the handsfree speakerphone and a headset. The speakerphone status light changes to let you know when the speakerphone or headset is active. A steady light always indicates the speakerphone is active while a blinking light indicates the headset is active.
- **Hset/Spkr** – calls will be sent to the headset. By pressing the ◀/▶ button on the phone you can switch between the headset and the handsfree speakerphone. The speakerphone status light changes to let you know when the speakerphone or headset is active. A steady light always indicates the speakerphone is active while a blinking light indicates the headset is active.









[†] These services may have different names in your area, and may require paid subscription. Contact your telephone company for details.

Using the Directory

The Directory can store up to 50 names and numbers, which are displayed in alphabetical order. Up to 30 of the Directory entries can be stored as one-touch, on screen, softkey memories. See "**Softkey Memory**" section for more information.

Tip: Store all your Directory contacts the same way, either first name first, or last name first. This will make it easier to find names and numbers.

Adding a name and number to the Directory

1. Press the Directory button .
2. Press the **ADDNew** softkey.
3. Enter the number using the dial pad. You can enter up to 24 digits. Hyphens will be automatically added. If you need to enter a pause (between your voice mail number and password, for example), press the **PAUSE** softkey. The pause icon  will appear. To program a number that uses Flash, press  where it is required in the number. The Flash icon  will appear. Press the **BACKSPACE** softkey or  to erase a number.
4. Press .
5. Enter a name using the letters on the dial pad. See the following instructions "**Entering Letters and Characters**" to enter names using the dial pad. The name can have up to 16 characters, including spaces. Press the **NEXTSPACE** softkey or  to move to the next letter or add a space. Press the **BACKSPACE** softkey or  to erase a character.
6. Press . The new entry now shows on the display.



7. To assign the Directory listing a Speed Dial key, see "**Softkey Memory**" section for further information.

Note: You can also copy an entry from the Callers List to the Directory using the  button, before or after you have changed it.

Entering Letters and Characters

You can enter characters using the telephone's dial pad. To enter a letter, press the key with that letter on it. If the letter is the second one on that key, press the key twice. For example, to enter 'R', press  three times. The cursor will advance to the next space after a delay of 2 seconds or if you press a different key.



To change the case of a letter, press the **CHANGECase** softkey, and then enter the letter. By default the first letter of a word or name will be capitalized, and the letters following will be lower case.

Special characters are entered by pressing the  and the  keys. Characters will appear in this order:



: ! , < > ` . - 1.

: # / \ @.







Finding entries in the Directory

1. Press the Directory button .
2. Once in the Directory, press  to scroll down and  to scroll up one listing at a time. Hold either key down to scroll continuously.



OR

Press a dial pad key to see listings that start with that letter. For example,  takes you to the first "J" listing,  takes you to the first "K" listing.

Changing entries in the Directory

1. Press the Directory button .
2. Find the entry you would like to change.
3. Press the **Change** softkey.
4. To change the number, use the **Backspace** softkey or  to erase digits. Use the dial pad to add digits. Use the **Pause** softkey to insert a 2 second pause. The pause icon  will appear.
5. Press  to move to the name.
6. To change the name, use the **Backspace** softkey or  to erase letters. Use the dial pad and the **NextSpace** softkey to add letters. Press the **ChangeCase** softkey to switch between upper and lower case.
7. Press  to save changes.

Copying from the Callers List, the Redial List, or the Display to the Directory

1. Open the Callers List, Redial List, or answer a call.
2. When the number is displayed on the screen, press . If the entry includes a name and number, the display will show **Saved: Directory**.
3. If the entry is a number only (such as in the Redial List), you will be prompted to enter a name. Once you've pressed  to save the name, the display will show **Saved: Directory**.

Dialing from the Directory

1. Press the Directory button .
2. Find the entry you would like to call in the Directory.

3. Lift the handset to dial the number, or press the **Dial** softkey or  to dial the number using Handsfree.

Deleting an entry in the Directory

1. Press the Directory button .
2. Find the entry you would like to delete.
3. Press the **Delete** softkey.
4. Press the **Delete** softkey again to confirm.

Deleting all entries in the Directory



Once you have deleted the Directory, you cannot get entries back. You can protect the Directory by locking it.

To permanently delete all entries in the directory:



1. Press the Directory button  to open the Directory.
2. Press the **DeleteList** softkey.
3. Press the **Delete** softkey to confirm.

Locking the Directory

You can lock the Directory so that entries cannot be deleted or changed. You cannot add entries to a locked directory.

1. Press .
2. Press .
3. Press . The display shows **Directory Locked**.

To unlock the Directory

1. Press .
2. Press .
3. Press . The display shows **Directory Unlocked**.

Softkey Memory





The Softkey Memory can store up to 30 one touch Speed Dial numbers.

There are six softkeys per screen or page, so the thirty numbers are spread out over five pages. Use the navigational arrow buttons to change pages. Page 1 buttons appear each time you originate a call, so we recommend that you place your most frequently dialed numbers or feature codes on this page.

Tip: Any entry in the Directory, Caller's list or Redial list can be assigned to a speed dial button.

Saving a name and number to a Softkey Button

1. Press .
2. You are automatically on Page 1 and you can either
 - press one of the vacant Speed Dial buttons on this page or
 - scroll to another page (P-2 to P-5) using the arrow buttons and then press a vacant **Speed Dial** softkey.
3. Enter the telephone number using the dial pad. You can enter up to 24 digits.

Note: Hyphens will be automatically added. If you need to enter a pause (between your voice mail number and password, for example), press the **Pause** softkey. The pause icon  will appear (2 seconds each). To program a number that uses Flash, press  where it is required in the number. The Flash icon  will appear. Press the **BACKSPACE** softkey or  to erase a number. If you are entering a PBX code and want the phone to automatically hang-up once the code is dialed, press the **HANG-UP** softkey (top right) as the last digit.

4. Press .



5. Enter a name/label for the button using the letters on the dial pad.

Note: Only the first 9 characters will display next to the softkey. If no name is entered, the telephone number will appear instead.

6. Press .

Tip: For more options when entering a name, read "Entering Letters and Characters" in the Using the Directory section of this guide.

Finding entries in the Speed Dial Directory

1. Press the Directory button .
2. Press **Speed Dial** (second softkey on the left).
3. Press the  to scroll through the list or press the first letter of the name.

Changing A Speed Dial Entry

Since the speed dial entries are in the directory, you can change/edit the name or number by following the instructions in the Directory section or by editing the speed dial button directly on the screen.

To directly edit a Speed Dial softkey

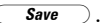
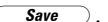

1. Scroll to the Speed dial page to find the entry to edit using the arrow buttons.
2. Press .
3. Press the softkey to Change/Edit the number and press .
4. Edit the name and press .

To Delete a Speed Dial softkey

There are two methods available to delete a Speed Dial entry. One method erases only the Speed Dial softkey and saves a copy in the Directory. The second permanently erases the entry from the telephone (no recovery is possible).

To only Erase the Speed Dial Softkey

To erase the speed dial softkey,

1. Press the Directory button .
2. Press **Speed Dial** (second softkey on the left).
3. Press  to scroll through the list or press the first letter of the name to locate the entry to be deleted.
4. Press **Delete** twice.

Note: A copy of the entry still resides in the Directory in case you want to assign the number to a different Speed Dial button.



To completely Erase the entry from the telephone

To permanently Erase the entry,



1. Press the Directory button .
2. Scroll to the Directory entry to be deleted using the arrow buttons or the keypad letters.
3. Press **Delete** twice.

Locking the Speed Dial softkey

You can lock the Directory so that Speed Dial and Directory entries cannot be deleted or changed. You can only copy Caller List and Redial List entries to a Speed Dial Button once the Directory is locked.

1. Press the Options button .
2. Press .
3. Press . The display shows **Directory Locked**.

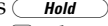
To unlock Speed Dial and Directory

1. Press the Options button .
2. Press .
3. Press . The display shows **Directory unlocked**.

Dialing Using a Speed Dial softkey

1. Locate the page containing the desired Speed Dial softkey.
2. Press the Speed Dial softkey. The speakerphone will be automatically engaged and the number will be dialed.



Note: The Speed Dial page will revert to Page 1 once the Speed Dial softkey is pressed to originate the call.

To place a Speed Dial call with the handset

1. Lift the handset first.
2. Locate the Speed Dial page.
3. Press the Speed Dial softkey. The number will be dialed.

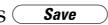

Note: The Speed Dial page will revert to Page 1 once the button is pressed to originate the call.

Assigning a Caller's List Entry to a Speed Dial softkey

1. Scroll through the Caller's List to display the entry you want to place in a Speed Dial softkey.
2. Press .
3. Press  until the desired Speed Dial Page is reached with a vacant button.
4. Press the Speed Dial softkey.

Note: If the Speed Dial softkey already has an entry, the old entry will be replaced by the new. The old entry will not be erased as a copy is still in the directory. That copy can be assigned to another vacant button if desired.

Assigning a Redial List Entry to a Speed Dial softkey

1. Scroll through the Redial List to display the entry you want to place in a Speed Dial softkey.
2. Press .
3. Press  until the desired Speed Dial Page is reached with a vacant button
4. Press the Speed Dial softkey.

Note: If the Speed Dial softkey already has an entry, the old entry will be replaced by the new. The old entry will not be erased as a copy is still in the directory. That copy can be assigned to another vacant button if desired.

Assigning a Directory Entry to a Speed Dial softkey



1. Scroll through the Directory to display the entry you want to place in a Speed Dial softkey.
2. Press **Assign** (second softkey on left).
3. Press  until the desired Speed Dial Page is reached with a vacant button
4. Press the Speed Dial softkey.

Note: If the Speed Dial softkey already has an entry, the old entry will be replaced by the new. The old entry will not be erased as a copy is still in the directory. That copy can be assigned to another vacant button if desired.

Moving a Speed Dial Entry to a different blank Button

This process requires [A] Removing the entry from the first Speed Dial softkey and [B] Assigning it to the new softkey.

[A] Removing the Speed Dial entry

1. Press the Directory button .
2. Press the  to scroll through the list or press the first letter of the name to locate the entry to be removed.
3. Press **Remove** (second softkey on left).

[B] Assigning a Directory Entry to the New Speed Dial softkey.

4. Now scroll through the Directory or press the first letter of the name to display the entry you want to Assign to the new Speed Dial softkey.
5. Press **Assign** (second softkey on left).
6. Press  until the desired Speed Dial Page is reached .
7. Press the new Speed Dial softkey.

Saving a feature and light to a softkey button

You can make the set indicator light come ON when you turn a feature ON and go OFF when you turn that same feature OFF. You can only do this with one feature. This works well with any service that has separate ON and OFF codes such as Call Forwarding. For example, you may want the light to remind you that you have turned Call Forwarding ON.

To do this, use one Speed Dial Memory softkey to turn the indicator light ON when you activate the feature. Use the second key to turn the indicator light OFF when you deactivate that same feature. The following procedure shows you how to program a FeatureLight ON and OFF key.

To save a FeatureLight ON softkey button:

1. Press **Save** . Do NOT press a **Speed Dial** softkey yet.
2. To program the light ON, press 1.
3. Press the desired softkey button.
4. Enter the telephone company feature code for turning the feature ON.[†]
5. Press **Save** to move to the name.
6. Enter feature name
7. Press **Save** to save the name.

To save a FeatureLight OFF softkey button:

1. Press **Save** . Do NOT press a **Speed Dial** softkey yet.
2. To program the light OFF, press 0.
3. Press the desired softkey button.
4. Enter the telephone company feature code for turning the feature OFF.[†]
5. Press **Save** to move to the name.
6. Enter feature name.
7. Press **Save** to save the name.

[†]Contact your telephone company or Telecom manager for the appropriate feature codes.

Using FeatureLight keys

To turn a feature and light ON or OFF:





1. Press the softkey button where you stored the FeatureLight ON. The light indicator is turn ON and display shows **Feature ON**.
2. Press the softkey button where you stored the FeatureLight OFF. The light indicator is turn OFF.

Using the Callers List

The Callers List records the last 50 callers, in the order they called. The telephone display will indicate when there are new callers.



When the Callers List is full, new callers are added to the list, and the oldest callers are deleted. In the Callers List you will see the message **XX New caller(s)**, **XX Call(s) bumped** on the display.

Viewing the Callers List



1. Press the Callers button .
2. Press  and  to move up and down in the Callers List. Hold either key down to scroll continuously. You can also press the **Resume** softkey to see the last caller you viewed the previous time you entered the Callers List.
3. Press the Callers button , the **Quit** softkey, or **Goodbye** at any time to leave the Callers List.

Note: **Goodbye** will also hang up a caller if you are on a call.

Calling an entry in the Callers List

1. Press the Callers button .
2. Find the entry you would like to call in the Callers List.
3. Lift the handset to dial the number, or press the **Dial** softkey or  to dial the number using Handsfree.

Copying from the Callers List to the Directory or Speed Dial softkey



When the number is displayed in the Callers List, press **Save**. The display will show **Save to?:**. Press the **Directory** button  to save to the directory. Press the  /  buttons and a softkey button to save the number in a softkey memory.

If the entry in the Callers List does not have a name (i.e. if the name is listed as **Unknown** or **Private**), you will be prompted to enter a name. You can edit a number in the Callers List and then copy it to the Directory. Press **Save** to end.

Changing a number in the Callers List before dialing

Tip: If you have to frequently remove area codes to return local calls, you should use the **Area Codes** option and add your local area code(s).

Note: The Callers List does not save changes. If you plan to dial the number again, copy it to the Directory and change it there.

1. Press the Callers button .
2. Find the caller in the Callers List you wish to dial.
3. To add digits, use the dial pad.
4. To delete digits, press the **Edit Num** softkey to begin editing. Use the dial pad to add digits.
5. Lift the handset to dial the number, or press the **Dial** softkey or  to dial the number using Handsfree.

Deleting an entry in the Callers List

1. Press the Callers button .
2. Find the entry you would like to delete in the Callers List.
3. Press the **Delete** softkey.
4. Press the **Delete** softkey again to confirm. The display shows **Item is erased**.

Deleting all entries in the Callers List

1. Press the Callers button .
2. Press the **Delete List** softkey.
3. Press the **Delete** softkey to confirm. The display shows **Callers list is empty**.



Headset/ Dataport Operation

Using a Headset with your Telephone

The Model 470 is equipped to accept headsets with a standard 2.5mm jack . These can be plugged into the headset jack located on the left hand side of the telephone.

Contact your telephone equipment retailer or distributor to purchase a headset. Customers should read and observe all safety recommendations contained in headset operating guides when using any headset.

Making and Receiving Calls using a Headset

1. Ensure that you have selected a headset audio mode by accessing the Options menu. See the section "**Customizing your phone**" for detailed information.
2. Press the  key to obtain dialtone or answer an incoming call. Depending on the audio mode selected from the Options menu, dialtone or an incoming call will be received on either the headset or the handsfree speakerphone.
3. Press the  key to end the call.

Using the Dataport





Located on the right hand side of the Model 470, the dataport can be used to connect another device such as a fax machine or computer modem to the phone. Plug one end of a line cord to the phone and the other end to the device to be connected.

Note: The dataport will only operate when the handset is on hook (in the phone base cradle).





Icons

The display uses icons to convey information about calls, Directory entries, Callers, and services.



Icons in the Callers List

	You are viewing the Callers List.
	You answered the call when it came in.
	You did not answer the call when it came in.
	You were on another call when this call came in.
	You have returned the call from the Callers List.

Icons in the Directory

	You are viewing the Directory.
	You pressed  , or Flash has been programmed into a number.
	You pressed the Pause softkey or a pause (which is about 2 seconds) has been programmed into a number.
	You have inserted the Hang Up command at the end of a programmed number, which tells the phone to disconnect after dialing.

Other List Icons

	You are viewing the Redial List.
	You are viewing the Options List.

Troubleshooting

Why are there no prompts on the screen when a Call Waiting call comes in?

You must subscribe to Call Waiting Identification[†] from your telephone company.

Why is the light not coming on with a new Voice Mail Message?

You must subscribe to the “Visual” Message Waiting[†] service from your telephone company for this function to work.

Why don't numbers I return from the Callers List connect?

Incoming calls are recorded with the area code attached, whether they are long distance or local calls. You may have to remove the area code from local calls in order to call from the Callers List, or use the Area Code option in the options list to have local area codes automatically removed. See the section “Customizing your phone” for information about the Area Code option. Alternatively, you may need to add ‘1’ before long distance numbers in order to dial long distance.

Why is my handset not working?

Check to ensure that the handset cord is fully connected to both the phone and handset.

Why is my display blank?

Ensure that the power adaptor is fully plugged into the electrical outlet, and that the outlet is supplying power (you can test this with another electrical device, such as a lamp).

How do I set the time and date?

If you subscribe to the Caller ID[†] service, the first incoming call will update the phone with the correct time & date. Otherwise, use the Time/Date option in the options list to manually set the time and date.

Why can I only see 4 options when the user guide says there are 9?

The telephone screen will only show 4 options at a time. To see more, press the down arrow button .

How do I remove the stand from the phone?

Place one hand on top of the phone, and place the other hand on the top of the stand. Pull the stand away from the telephone. You will have to pull quite forcefully, but this will not break the stand.

Can I turn the light on the screen off?

No. You can only adjust the contrast of the display.

Why are Callers not identified on the display?

Caller ID[†] information usually arrives between the first and second ring. Let the telephone ring at least once before answering. Make sure you subscribe to Caller ID[†] services from your local telephone company.

Why can't I dial a number in the Callers List?

You must subscribe to a Caller ID[†] service for names and/or numbers to be recorded in the Callers List. If the number of the caller is unknown

or private, you cannot return the call. Or, the number may require an area code. Press the **EditNum** softkey to edit the number, then press the **Dial** softkey.

Why can't I hear a caller or be heard?

Increase the receiver or speaker volume. Make sure the handset cord is inserted securely into the jack. If the speaker light is flashing, the call is muted; press the **M** key to turn mute off; the light will be steady and not flashing.

Why does the telephone wobble?

Make sure the cords are routed properly through the stand, as indicated in the Installation section. Check that the stand has been properly snapped into place.

What does Hold Msg do?

This is an option available with some Call Waiting[†] services. When you are on a call, and another call comes in on Call Waiting, you can press the **Hold Msg** softkey to send a network message to the caller. The message will ask the caller to hold, and tell them that you will be with them shortly. You can then answer the call at your convenience. Contact your local telephone company for activation information.

What does Answ. CW or Swi tch do?

This is an option available with some Call Waiting[†] services. These softkeys allow you to put the current call on hold, and answer a Call Waiting call. You can then

switch between calls normally. Contact your local telephone company for activation information.

What is a softkey?

There are three keys on both the left and right side of the display. They do different things, depending on the command displayed next to them. See the section "**How do I use softkeys?**" for more information.

[†] These services may have different names in your area. Contact your telephone company for details.

If you've read this owner's manual and consulted the Troubleshooting section and still have problems, please visit our website at www.aastra.com or call 1-800-574-1611 for technical assistance.

© Aastra Telecom 2003
D0041-0046-00-00 Rev.00

Limited Warranty

Aastra Telecom warrants this product against defects and malfunctions during a one (1) year period from the date of original purchase. If there is a defect or malfunction, Aastra Telecom shall, at its option, and as the exclusive remedy, either repair or replace the telephone set at no charge, if returned within the warranty period.

If replacement parts are used in making repairs, these parts may be refurbished, or may contain refurbished materials. If it is necessary to replace the telephone set, it may be replaced with a refurbished telephone of the same design and color. If it should become necessary to repair or replace a defective or malfunctioning telephone set under this warranty, the provisions of this warranty shall apply to the repaired or replaced telephone set until the expiration of ninety (90) days from the date of pick up, or the date of shipment to you, of the repaired or replacement set, or until the end of the original warranty period, whichever is later. Proof of the original purchase date is to be provided with all telephone sets returned for warranty repairs.

Exclusions

Aastra Telecom does not warrant its telephone sets to be compatible with the equipment of any particular telephone company. This warranty does not extend to damage to products resulting from improper installation or operation, alteration, accident, neglect, abuse, misuse, fire or natural causes such as storms or floods, after the telephone is in your possession.

Aastra Telecom shall not be liable for any incidental or consequential damages, including, but not limited to, loss, damage or expense directly or indirectly arising from the customers use of or inability to use this telephone, either separately or in combination with other equipment. This paragraph,

however, shall not apply to consequential damages for injury to the person in the case of telephones used or bought for use primarily for personal, family or household purposes.

This warranty sets forth the entire liability and obligations of Aastra Telecom with respect to breach of warranty, and the warranties set forth or limited herein are the sole warranties and are in lieu of all other warranties, expressed or implied, including warranties or fitness for particular purpose and merchantability.

Warranty Repair Services

Should the set fail during the warranty period;

In North America, please call 1-800-574-1611 for further information.

Outside North America, contact your sales representative for return instructions.

You will be responsible for shipping charges, if any. When you return this telephone for warranty service, you must present proof of purchase.

After Warranty Service

Aastra Telecom offers ongoing repair and support for this product. This service provides repair or replacement of your Aastra Telecom product, at Aastra Telecom's option, for a fixed charge. You are responsible for all shipping charges. For further information and shipping instructions;

In North America, contact our service information number: 1-800-574-1611.

Outside North America, contact your sales representative.

Note: Repairs to this product may be made only by the manufacturer and its authorized agents, or by others who are legally authorized. This restriction applies during and after the warranty period. Unauthorized repair will void the warranty.

A

- Area Code 9, 17
- Audio Mode 7, 9, 17

B

- Backlit Display 2, 3, 20

C

- Callers List
 - Calling an entry 17, 20
 - Changing a listing 17
 - Copying from 12, 14
 - Deleting all entries 17
 - Deleting an entry 17
 - Viewing 17
- Contrast Level 9

D

- Dataport 2, 18
- Date and Time 9
- Directory
 - Adding name/number 11
 - Changing entries 11
 - Copy to 12
 - Deleting all entries 12
 - Deleting an entry 12
 - Dialing from 12
 - Entering
 - letters/characters 11
 - Finding entries 11
 - Key 3
 - Locking 12
 - Unlocking 12

Display

- Contrast
 - See Contrast Level
- Language 9

Prompts 6

E

- Emergency Service Feature 1
- Extension in Use 7

F

- Flash 7, 11, 13
- Flash Icon 19
- Flash Key 3
- Feature Light 16

G

- Goodbye key 3

H

- Handsfree calling 3, 7
- Hang up softkey 13
 - Icon 19
- Headset
 - Jack 2
 - Making calls 18
 - Receiving calls 18
- Hold key 3, 8

I

- Icons 19
- Insert Number Card 5
- Installation 4

K

- Key Description 2, 3

L

- Language selection
 - See Display
- Lights See Status Lights
- Live Dialpad 7, 9

Index

M

- Message Waiting 6, 8, 9
- Mute key 3

O

- Options
 - Area Code 9
 - Audio Mode 9
 - Clear Message Waiting 9
 - Contrast level 9
 - Language 9
 - Live Dialpad 9
 - Ring Tone 9
 - Security Numbers 9
 - Time/Date 9
- Options key 3

P

- Pause
 - Icon 19
 - Inserting 11, 12, 13
- Predialing 7
- Prompts 6

R

- Redial key 3
- Redial List
 - Deleting List 7
 - Redialing a number 7
- Ringer
 - ON/OFF 6
 - Tone 9
 - Volume 8

S

- Security Numbers 9
- Softkeys 6

- Softkey Memory 13

- Saving to 13
- Finding entries 13
- Editing 13
- Deleting 14
- Locking 14
- Unlocking 14
- Dialing from 14
- Copying from
 - Callers List 14
 - Redial list 14
 - Directory 15
- Moving between 15
- Saving feature light 15,16

Speaker

- Key 3
- Light See Status Lights
- Operation 7

Stand 4, 20

Status Lights

- Speaker 8
- Telephone 8

T

- Timing a call 7
- Troubleshooting 20

V

- Voice Mail 6, 20
- Volume
 - Handset 8
 - Key 3
 - Ringer 8
 - Speaker 8

W

- Warranty 22

